

ECEN 667

Power System Stability

Lecture 5: Transient Stability Intro

Prof. Tom Overbye

Dept. of Electrical and Computer Engineering

Texas A&M University

overbye@tamu.edu



TEXAS A&M
UNIVERSITY

Announcements



- Read Chapter 3, skip 3.7 for now
- Homework 1 is due today
- Homework 2, which is posted on the website, is due on Thursday Sept 21

Converting Between Phase and Sequence Values



- As derived in an undergraduate class, sequence values (positive, negative, zero) and matrices can be easily calculated by defining

$$\alpha \triangleq 1\angle 120^\circ, \quad \mathbf{A} = \begin{bmatrix} 1 & 1 & 1 \\ 1 & \alpha^2 & \alpha \\ 1 & \alpha & \alpha^2 \end{bmatrix}$$

This is needed for HW 2, problem 1

$$\mathbf{V}_s = \begin{bmatrix} V_a \\ V_b \\ V_c \end{bmatrix} = \mathbf{A} \mathbf{V}_p = \mathbf{A} \begin{bmatrix} V^0 \\ V^+ \\ V^- \end{bmatrix}$$

$$\mathbf{Z}_s = \mathbf{A}^{-1} \mathbf{Z}_p \mathbf{A}$$

Inserting Transient Stability Contingency Elements



Click to insert new elements

Summary of all elements in contingency and time of action

The screenshot shows the 'Transient Stability Analysis' window with a table of contingency elements. A red arrow points to the 'Enabled' column of the second row, with the text 'Right click here And select "show dialog" To reopen this Dialog box'. Another red arrow points from this text to the 'Clear Fault' option in the 'Transient Stability Contingency Element Dialog' box. A black arrow points from the 'Insert Elements' button in the main window to the text 'Click to insert new elements'. Another black arrow points from the 'Object Pretty' column of the second row to the text 'Summary of all elements in contingency and time of action'.

Object Pretty	Enabled	Time (Seconds)	Object	Description
1 Bus Bus 1	YES	1.0000	Bus '1'	
2 Bus Bus 1	YES	1.0500	Bus '1'	CLEARFAULT

Transient Stability Contingency Element Dialog

Description: 1.0500: [Bus Bus 1] CLEARFAULT

Object Type: Bus

Choose the Element: Name Number

- 1 (Bus 1) [138 kV]
- 2 (Bus 2) [138 kV]
- 3 (Bus 3) [138 kV]
- 4 (Bus 4) [13.8 kV]

Time (Seconds): 1.05000

Description: Type Apply Fault Clear Fault

Parameters: Fault Type: Balanced 3 Phase, Fault Across: Solid, PU Resistance: 0.000, PU Reactance: 0.000

Buttons: OK, Save, Insert, Delete, Help, Cancel

Available element type will vary with different objects

Determining the Results to View



- For large cases, transient stability solutions can generate huge amounts of data. PowerWorld Simulator provides easy ways to choose which fields to save for later viewing. These choices can be made on the “Result Storage” page.
- For this example we’ll save the generator 4 rotor angle, speed, MW terminal power and Mvar terminal power.
- From the “Result Storage” page, select the generator tab and double click on the specified fields to set their values to “Yes”.

Result Storage Page



Result Storage Page

Simulation Status: Not Initialized

Run Transient Stability | Pause | Abort | For Contingency: My Transient Contingency

Select Step

- Simulation
- Options
- Result Storage
 - Store to RAM Options
 - Generator
 - Bus
 - Load
 - Branch
 - DC Transmission Line
 - Area
 - Zone
 - Save to Hard Drive Options
- Plots
- Results
- Transient Limit Monitors
- States/Manual Control
- Validation
- SMIB Eigenvalues

Process Contingencies

One Contingency at a time (selected)

Multiple Contingencies

Save All Settings To | Load All Settings From

Result Storage

Where to Save/Store Results: Save Results Every n Timesteps: 1

Store Results to RAM

Save Results to Hard Drive

Load from Hard Drive File into RAM results specified by Store to RAM Options

Save the Results stored to RAM in the PWB file

Store to RAM Options | Save to Hard Drive Options

Note: All fields that are specified in a plot series of defined plot will also be stored to RAM.

Store Results for Open Devices | Set All to NO for All Types | Set Save All by Type ...

Generator	Bus	Load	Branch	DC Transmission Line	Area	Zone	Number of Bus	Name of Bus	ID	Area Name of Gen	Save All	Rotor Angle	Rotor Angle, No Shift	Speed	Mech Input	MW Terminal	Accel MW	Mvar Terminal	Term. PU	Field Voltage (pu)	Field Current
	1						2	Bus 2	1	Home	NO	NO	NO	NO	NO	NO	NO	NO	NO	NO	NO
	2						4	Bus 4	1	Home	NO	YES	NO	YES	NO	YES	NO	YES	NO	NO	NO

From Selection: | Make Plot | Make Plot Group by Field | Make Plot Group by Object

Close

Generator Tab

Double Click on Fields (which sets them to yes) to Store Their Values

Saving Changes and Doing Simulation



- The last step before doing the run is to specify an ending time for the simulation, and a time step.
- Go to the “Simulation” page, verify that the end time is 5.0 seconds, and that the Time Step is 0.5 cycles
 - PowerWorld Simulator allows the time step to be specified in either seconds or cycles, with 0.25 or 0.5 cycles recommended
- Before doing your first simulation, save all the changes made so far by using the main PowerWorld Simulator Ribbon, select “Save Case As” with a name of **“Example_13_4_WithCLSMModel_ReadyToRun”**
- Click on “Run Transient Stability” to solve.

Doing the Run



Click
to
run
the
specified
contingency

The screenshot shows the 'Transient Stability Analysis' software interface. The 'Simulation Status' is 'Finished at 5.000'. The 'Run Transient Stability' button is highlighted with an arrow from the text 'Click to run the specified contingency'. The 'For Contingency' dropdown is set to 'My Transient Contingency'. The 'Simulation Time Values' section shows 'Start Time (seconds)' at 0.000, 'End Time (seconds)' at 5.000, and 'Time Step (cycles)' at 0.500. The 'Specify Time Step in' section has 'Cycles' selected. The 'Transient Contingency Elements' section shows a table with columns for 'Object Pretty', 'Time (Cycles)', 'Time (Seconds)', and 'Object'. The table contains two rows of data.

	Object Pretty	Time (Cycles)	Time (Seconds)	Object	
1	Bus Bus 1	60.0	1.0000	Bus '1'	FAULT 3F
2	Bus Bus 1	63.0	1.0500	Bus '1'	CLEARFA

Once the contingency runs the “Results” page may be opened

Transient Stability Results



- Once the transient stability run finishes, the “Results” page provides both a minimum/maximum summary of values from the simulation, and time step values for the fields selected to view.
- The Time Values and Minimum/Maximum Values tabs display standard PowerWorld Simulator case information displays, so the results can easily be transferred to other programs (such as Excel) by right-clicking on a field and selecting “Copy/Paste/Send”

Continuing PowerWorld Simulator Example



- Class will make extensive use of PowerWorld Simulator. If you do not have a copy of v19, the free 42 bus student version is available for download at
<http://www.powerworld.com/gloveroverbyesarma>
- Start getting familiar with this package, particularly the power flow basics. Transient stability aspects will be covered in class
- Open Example_13_4_WithCLSMModelReadyToRun
 - Cases are on the class website

Results: Time Values



Lots of options are available for showing and filtering the results.

The screenshot shows the 'Results from RAM' window in the Transient Stability Analysis software. The simulation is finished at 5.000. The 'Time Values' tab is selected, showing a table of results for Gen Bus 4 #1 Rotor Angle. The table has columns for Time, Gen Bus 4 #1 Rotor Angle, Gen Bus 4 #1 Speed, Gen Bus 4 #1 MW Terminal, and Gen Bus 4 #1 Mvar Terminal. The rotor angle starts at 20.18 at time 0 and remains constant at 20.18 for the rest of the simulation.

	Time	Gen Bus 4 #1 Rotor Angle	Gen Bus 4 #1 Speed	Gen Bus 4 #1 MW Terminal	Gen Bus 4 #1 Mvar Terminal
1	0	20.18	60	100	58.5305
2	0.008	20.18	60	100	58.5305
3	0.017	20.18	60	100	58.5305
4	0.025	20.18	60	100	58.5305
5	0.033	20.18	60	100	58.5305
6	0.042	20.18	60	100	58.5305
7	0.05	20.18	60	100	58.5305
8	0.058	20.18	60	100	58.5305
9	0.067	20.18	60	100	58.5305
10	0.075	20.18	60	100	58.5305
11	0.083	20.18	60	100	58.5305
12	0.092	20.18	60	100	58.5305
13	0.1	20.18	60	100	58.5305
14	0.108	20.18	60	100	58.5305
15	0.117	20.18	60	100	58.5305

By default the results are shown for each time step. Results can be saved every “n” timesteps using an option on the Results Storage Page

Results: Minimum and Maximum Values



Minimum and maximum values are available for all generators and buses

The screenshot shows the 'Transient Stability Analysis' software interface. The 'Results' tab is active, displaying a table of 'Minimum/Maximum Values' for buses. The table has columns for Number, Name, Area Name, Original Volt, Min Volt, Time Min Volt, Max Volt, Time Max Volt, and Max-Min V. The data is as follows:

Number	Name	Area Name	Original Volt	Min Volt	Time Min Volt	Max Volt	Time Max Volt	Max-Min V
1	1 Bus 1	Home	1.0477	1.0188	1.158	1.0616	4.792	0.
2	2 Bus 2	Home	1.0000	1.0000	1.058	1.0000	1.058	0.
3	3 Bus 3	Home	1.0303	1.0082	4.525	1.0409	4.792	0.
4	4 Bus 4	Home	1.0971	1.0630	3.575	1.1143	4.808	0.

The interface also includes a 'Select Step' tree on the left, a 'Process Contingencies' section at the bottom left with 'One Contingency at a time' selected, and buttons for 'Save All Settings To', 'Load All Settings From', and 'Close'.

Quickly Plotting Results



- Time value results can be quickly plotted by using the standard case information display plotting capability.
 - Right-click on the desired column
 - Select Plot Columns
 - Use the Column Plot Dialog to customize the results.
 - Right-click on the plot to save, copy or print it.
- More comprehensive plotting capability is provided using the Transient Stability “Plots” page; this will be discussed later.

Generator 4 Rotor Angle Column Plot

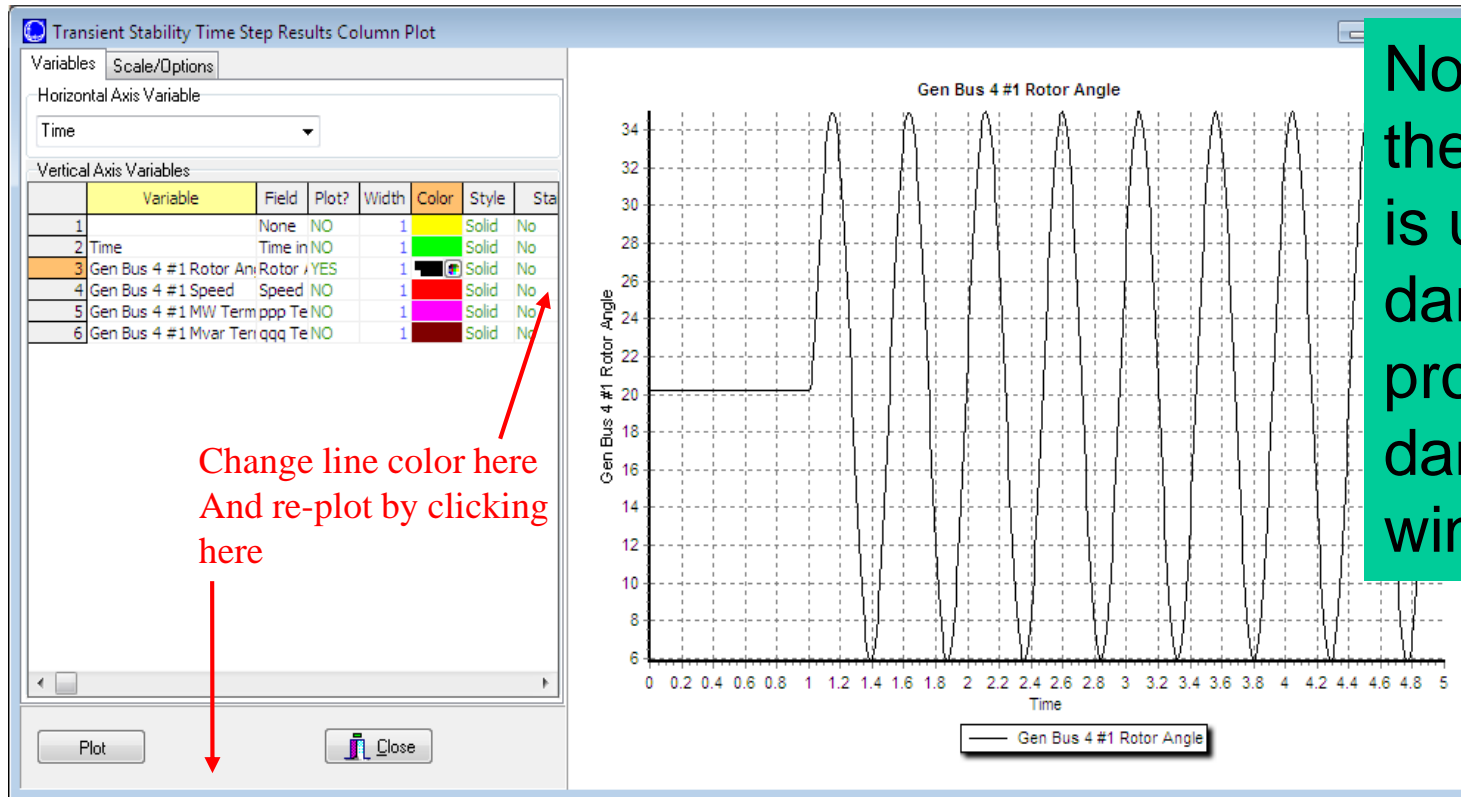

Notice that the result is undamped; damping is provided by damper windings

Starting the event at $t = 1.0$ seconds allows for verification of an initially stable operating point. The small angle oscillation indicates the system is stable, although undamped.

Changing the Case



- PowerWorld Simulator allows for easy modification of the study system. As a next example we will duplicate example 13.4 from earlier editions of the Glover/Sarma Power System Analysis and Design Book.
- Back on the one-line, right-click on the generator and use the Stability/Machine models page to change the Xdp field from 0.2 to 0.3 per unit.
- On the Transient Stability Simulation page, change the contingency to be a solid three phase fault at *Bus 3*, cleared by opening *both* the line between buses 1 and 3 and the line between buses 2 and 3 at time = *1.34 seconds*.

Changing the Contingency Elements

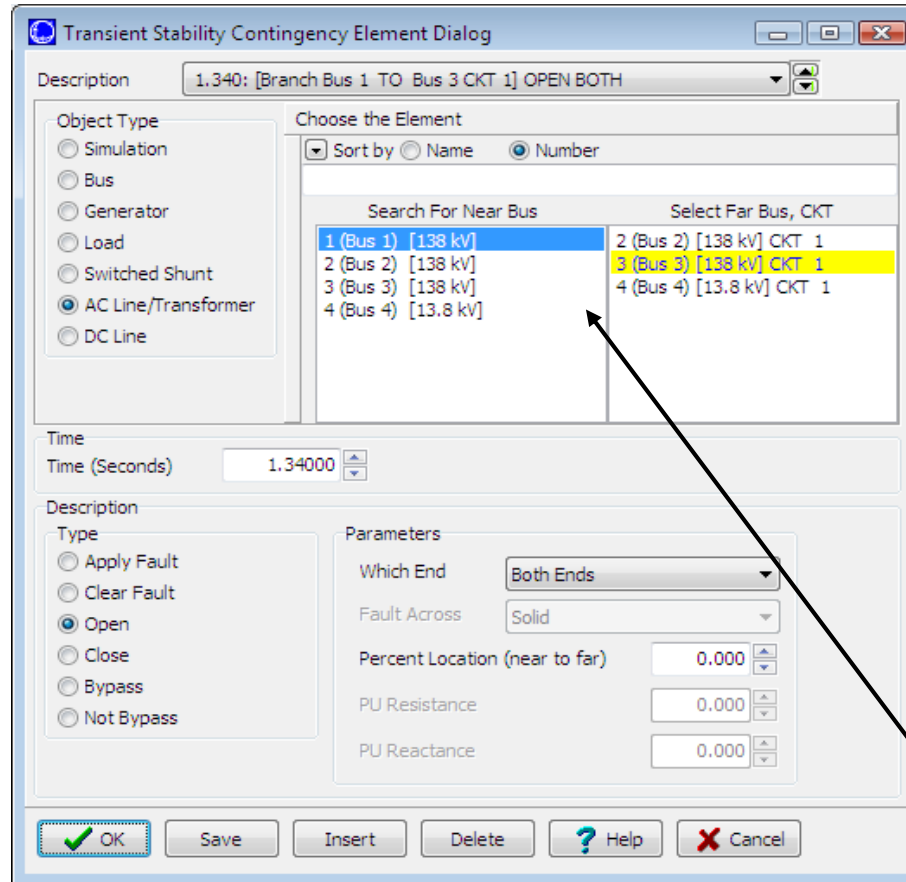

Change object type to AC Line/Transformer, select the right line, and change the element type to “Open”.

Changing the Contingency Elements



The screenshot shows the 'Transient Stability Analysis' software interface. The simulation status is 'Finished at 5.000'. The 'For Contingency' dropdown is set to 'My Transient Contingency'. The 'Simulation Time Values' section shows Start Time (0.000), End Time (5.000), and Time Step (0.500). The 'Transient Contingency Elements' table is displayed below.

	Object Pretty	Time (Cycles)	Time (Seconds)	Object	Description	Enabled
1	Bus Bus 3	60.0	1.0000	Bus '3'	FAULT 3PB SOLID	CHECK
2	Line Bus 1 TO Bus 3 CKT 1	80.4	1.3400	Branch '1' '3' '1'	OPEN BOTH	CHECK
3	Line Bus 2 TO Bus 3 CKT 1	80.4	1.3400	Branch '2' '3' '1'	OPEN BOTH	CHECK

Contingency Elements displays should eventually look like this. Note fault is at bus 3, not at bus 1.

Case Name: Example_13_4_Bus3Fault

Results: On Verge of Instability

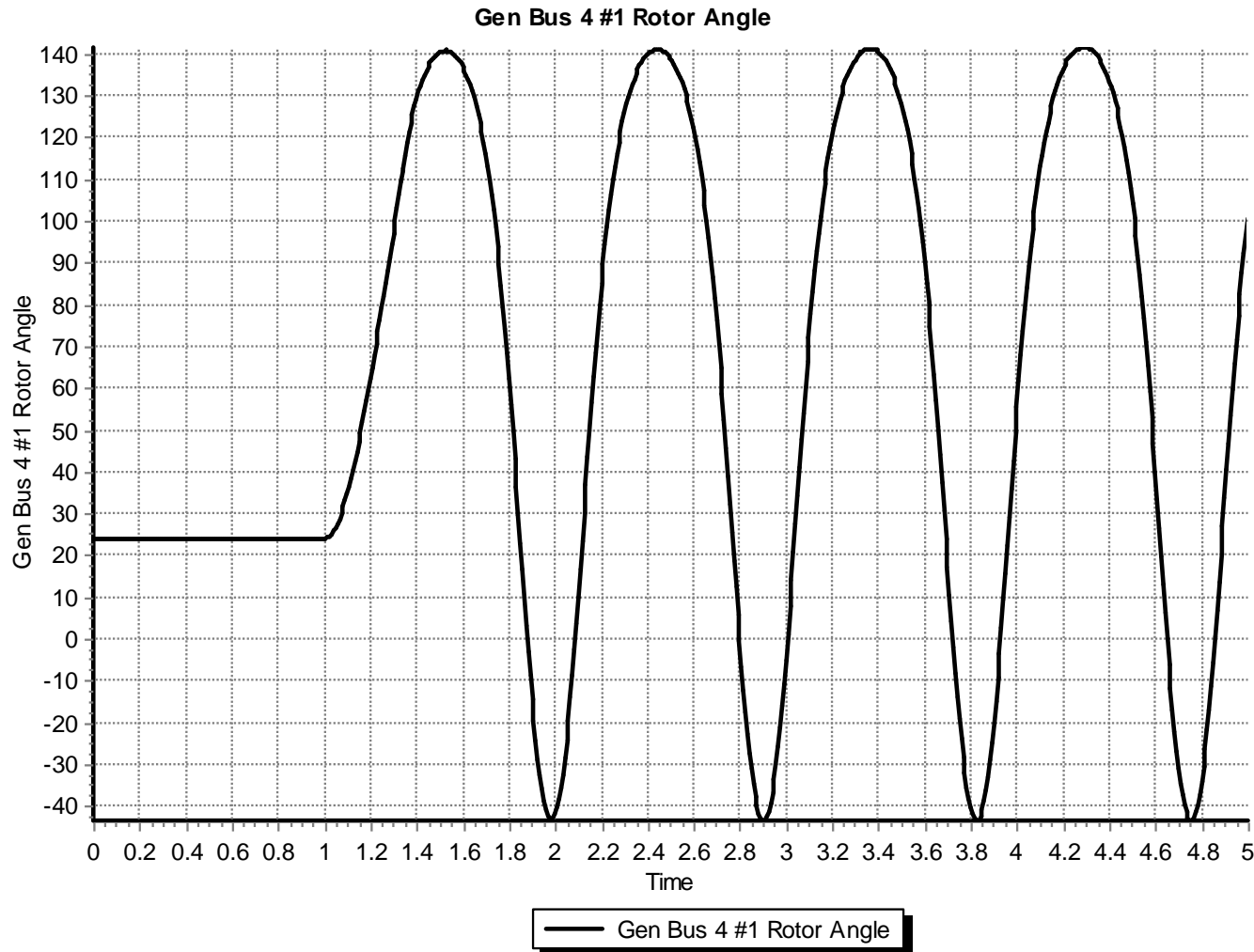

Also note that the oscillation frequency has decreased

A More Realistic Generator Model



- The classical model is considered in section 5.6 of the book, as the simplest but also the hardest to justify
 - Had been widely used, but is not rapidly falling from use
- PowerWorld Simulator includes a number of much more realistic models that can be easily used
 - Coverage of these models is beyond the scope of this intro
- To replace the classical model with a detailed solid rotor, subtransient model, go to the generator dialog Machine Models, click “Delete” to delete the existing model, select “Insert” to display the Model Type dialog and select the GENROU model; accept the defaults.

GENROU Model



Generator Information for Current Case

Bus Number: 4
Bus Name: Bus 4
ID: 1
Area Name: Home (1)
Labels: no labels

Find By Number
Find By Name
Find ...

Status: Open Closed
Generator MVA Base: 100.00

Fuel Type: Unknown
Unit Type: UN (Unknown)

Power and Voltage Control | Costs | OPF | Faults | Owners, Area, etc. | Custom | Stability

Machine Models | Exciters | Governors | Stabilizers | Other Models | Step-up Transformer | Terminal and State

Insert | Delete | Gen MVA Base: 100.0 | Show Diagram | Set to Default

Type: Active - GENROU Active (only one may be active) Defaults:

Parameters
PU values shown/entered using device base of 100.0 MVA

H	3.0000	Xdpp=Xqpp	0.1800	S(1.2)	0.0000
D	0.0000	Xl	0.1500	RComp	0.0000
Ra	0.0000	Tdop	7.0000	XComp	0.0000
Xd	2.1000	Tqop	0.7500		
Xq	0.5000	Tdopp	0.0350		
Xdp	0.2000	Tqopp	0.0500		
Xqp	0.5000	S(1.0)	0.0000		

OK Save Cancel Help Print

The GENROU model provides a good approximation for the behavior of a synchronous generator over the dynamics of interest during a transient stability study (up to about 10 Hz). It is used to represent a solid rotor machine with three damper windings.

Repeat of Example 13.1 with GENROU

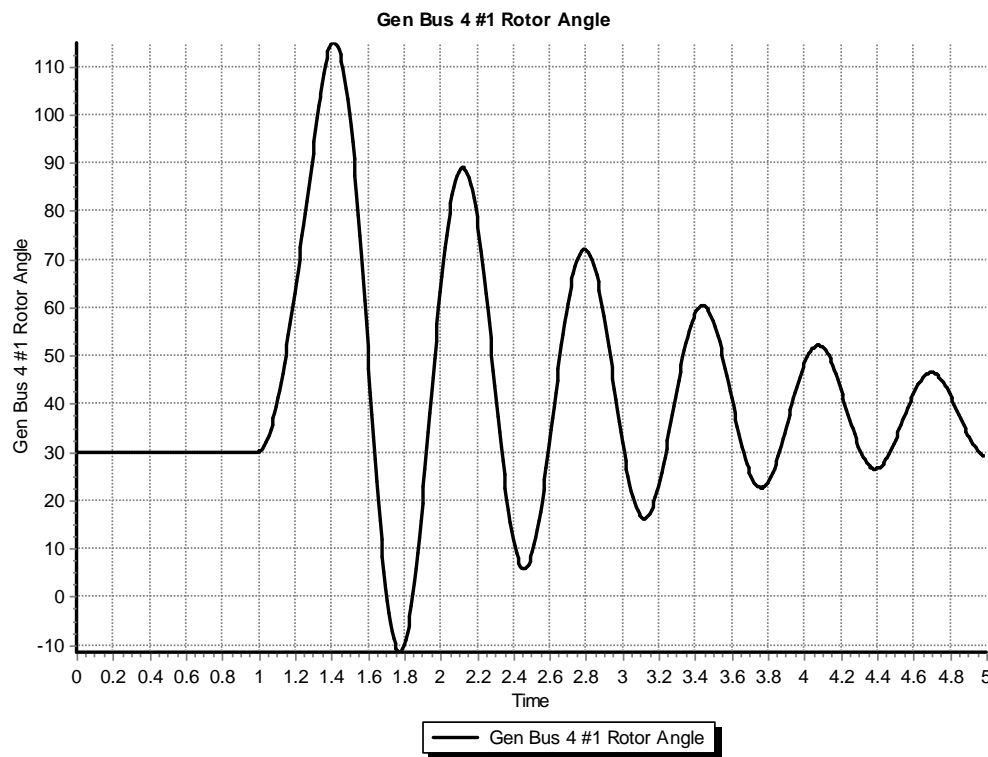

This plot repeats the previous example with the bus 3 fault. The generator response is now damped due to the damper windings included in the GENROU model. Case is saved in examples as **Example_13_4_GENROU**.

Saving Results Every n Timesteps



- Before moving on it will be useful to save some additional fields. On the Transient Stability Analysis form select the “Result Storage” page. Then on the Generator tab toggle the generator 4 “Field Voltage” field to Yes. On the Bus tab toggle the bus 4 “V (pu)” field to Yes.
- At the top of the “Result Storage” page, change the “Save Results Every n Timesteps” to 6.
 - PowerWorld Simulator allows you to store as many fields as desired. On large cases one way to save on memory is to save the field values only every n timesteps with 6 a typical value (i.e., with a $\frac{1}{2}$ cycle time step 6 saves 20 values per second)

Plotting Bus Voltage



- Change the end time to 10 seconds on the “Simulation” page, and rerun the previous. Then on “Results” page, “Time Values from RAM”, “Bus”, plot the bus 4 per unit voltage. The results are shown below.

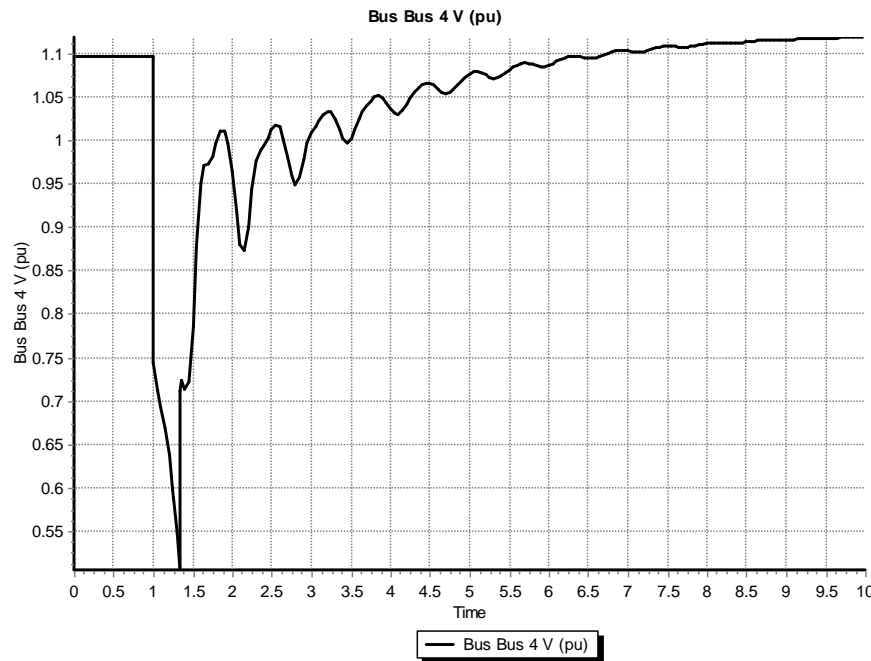

Notice following the fault the voltage does not recover to its pre-fault value. This is because we have not yet modeled an exciter.

Adding a Generator Exciter



- The purpose of the generator excitation system (exciter) is to adjust the generator field current to maintain a constant terminal voltage.
- PowerWorld Simulator includes many different types of exciter models. One simple exciter is the IEEE1. To add this exciter to the generator at bus 4 go to the generator dialog, “Stability” tab, “Exciters” page. Click Insert and then select IEEE1 from the list. Use the default values.
- Exciters will be covered in the first part of Chapter 4

IEEET1 Exciter



- Once you have inserted the IEEET1 exciter you can view its block diagram by clicking on the “Show Diagram” button. This opens a PDF file in Adobe Reader to the page with that block diagram. The block diagram for this exciter is also shown below.

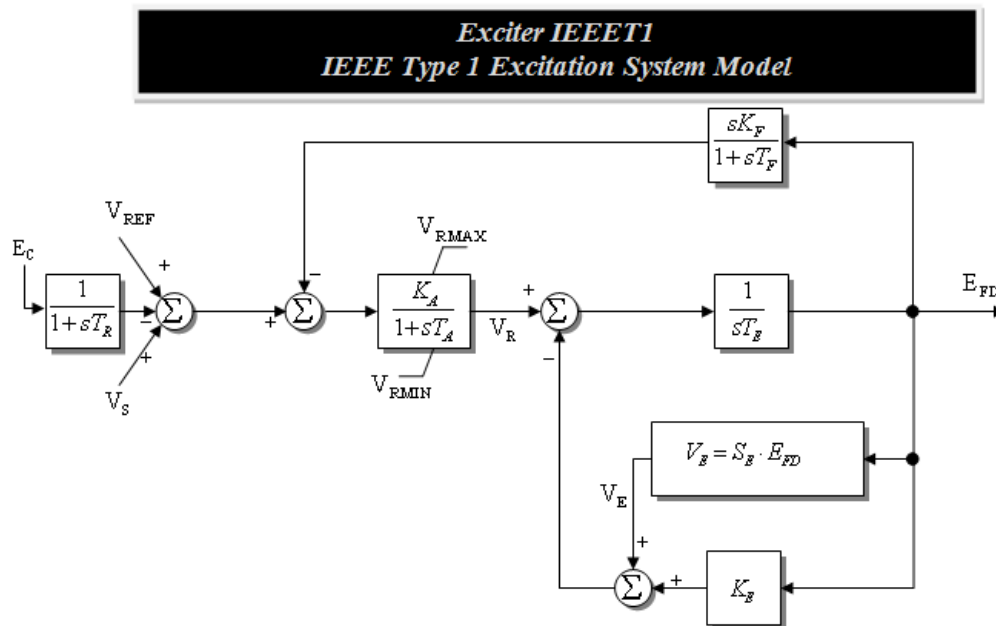

The input to the exciter, E_c , is usually the terminal voltage. The output, E_{FD} , is the machine field voltage.

Voltage Response with Exciter



- Re-do the run. The terminal time response of the terminal voltage is shown below. Notice that now with the exciter it returns to its pre-fault voltage.

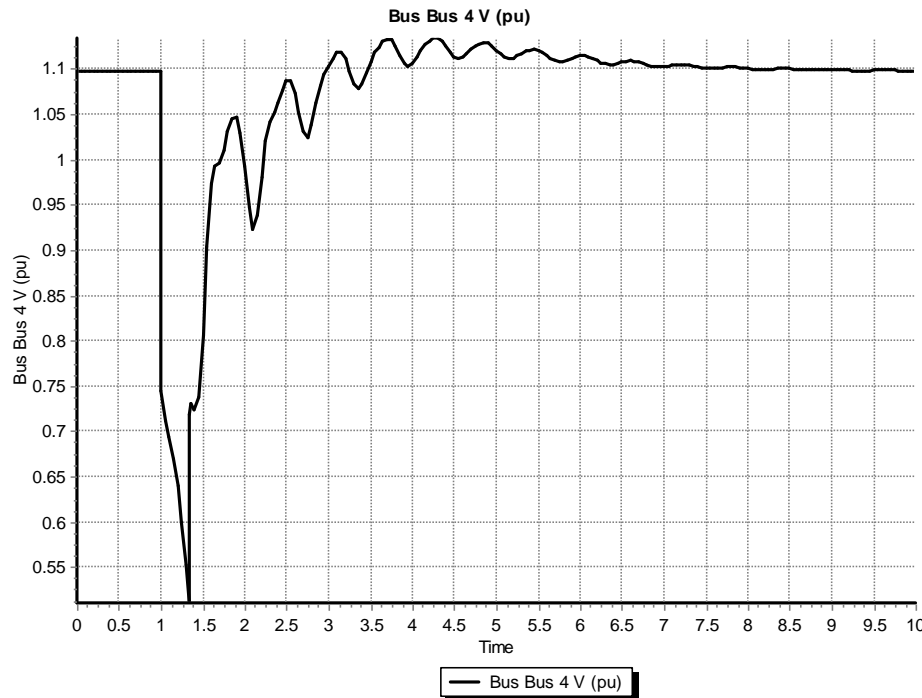

Case Name: Example_13_4_GenROU_IEEET1

Defining Plots



- Because time plots are commonly used to show transient stability results, PowerWorld Simulator makes it easy to define commonly used plots.
 - Plot definitions are saved with the case, and can be set to automatically display at the end of a transient stability run.
- To define some plots on the Transient Stability Analysis form select the “Plots” page. Initially we’ll setup a plot to show the bus voltage.
 - Use the Plot Designer to choose a Device Type (Bus), Field, (Vpu), and an Object (Bus 4). Then click the “Add” button. Next click on the Plot Series tab (far right) to customize the plot’s appearance; set Color to black and Thickness to 2.

Defining Plots



Plots Page

Plot Designer tab

Plot Series tab

Device Type

Field

Customize the plot line.

Object; note multiple objects and/or fields can be simultaneously selected.

Adding Multiple Axes



- Once the plot is designed, save the case and rerun the simulation. The plot should now automatically appear.
- In order to compare the time behavior of various fields an important feature is the ability to show different values using different y-axes on the same plot.
- To add a new Vertical Axis to the plot, close the plot, go back to the “Plots” page, select the Vertical Axis tab (immediately to the left of the Plot Series tab). Then click “Add Axis Group”. Next, change the Device Type to Generator, the Field to Rotor Angle, and choose the Bus 4 generator as the Object. Click the “Add” button. Customize as desired. There are now two axis groups.

A Two Axes Plot



- The resultant plot is shown below. To copy the plot to the windows clipboard, or to save the plot, right click towards the bottom of the plot. You can re-do the plot without re-running the simulation by clicking on “Generate Selected Plots” button.

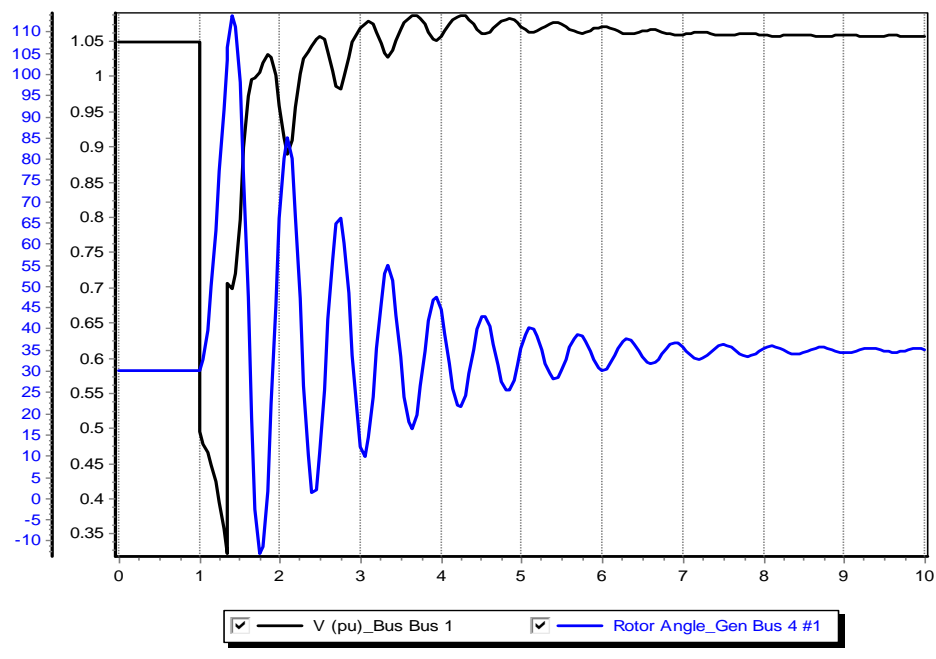

Many plot options
are available

This case is saved as
Example_13_4_WithPlot

Setting the Angle Reference



- Infinite buses do not exist, and should not usually be used except for small, academic cases.
 - An infinite bus has a fixed frequency (e.g. 60 Hz), providing a convenient reference frame for the display of bus angles.
- Without an infinite bus the overall system frequency is allowed to deviate from the base frequency
 - With a varying frequency we need to define a reference frame
 - PowerWorld Simulator provides several reference frames with the default being average of bus frequency.
 - Go to the “Options”, “Power System Model” page. Change Infinite Bus Model to “No Infinite Buses”; Under “Options, Result Options”, set the Angle Reference to “Average of Generator Angles.”

Setting Models for the Bus 2 Gen



- Without an infinite bus we need to set up models for the generator at bus 2. Use the same procedure as before, adding a GENROU machine and an IEEE1 exciter.
 - Accept all the defaults, except *set the H field for the GENROU model to 30* to simulate a large machine.
 - Go to the Plot Designer, click on PlotVertAxisGroup2 and use the “Add” button to show the rotor angle for Generator 2. Note that the object may be grayed out but you can still add it to the plot.
 - Without an infinite bus the case is no longer stable with a 0.34 second fault; on the main Simulation page change the event time for the *opening on the lines to be 1.10 seconds* (you can directly overwrite the seconds field on the display).
 - Case is saved as **Example_13_4_NoInfiniteBus**

No Infinite Bus Case Results

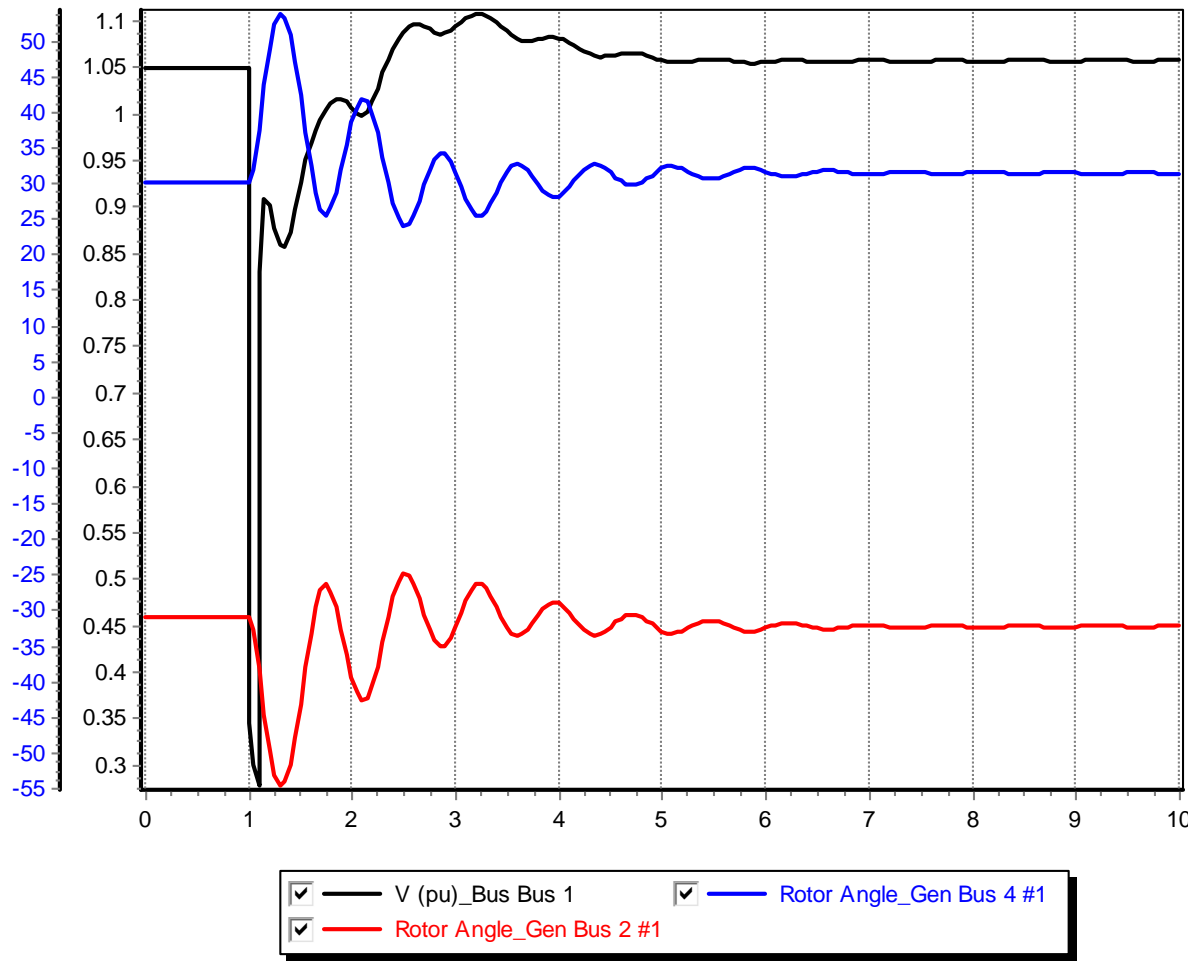

Plot shows the rotor angles for the generators at buses 2 and 4, along with the voltage at bus 1. Notice the two generators are swinging against each other.

Impact of Angle Reference on Results



- To see the impact of the reference frame on the angles results, go to the “Options”, “Power System Model” page. Under “Options, Result Options”, set the Angle Reference to “Synchronous Reference Frame.”

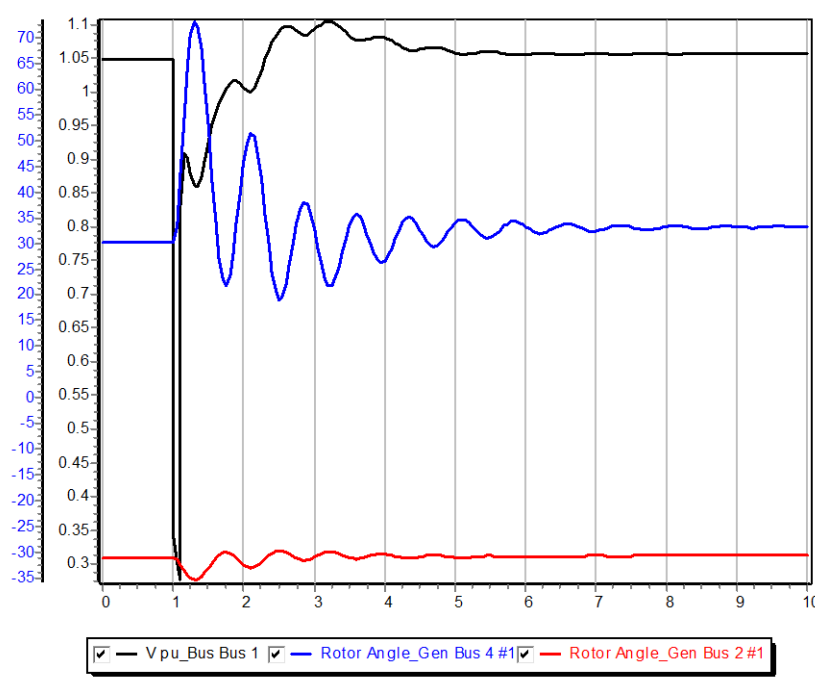

This shows the more expected results, but it is not “more correct.” Both are equally correct.

WSCC Nine Bus, Three Machine Case



- As a next step in complexity we consider the WSCC (now WECC) nine bus case, three machine case.
 - This case is described in several locations including EPRI Report EL-484 (1977), the Anderson/Fouad book (1977). Here we use the case as presented as Example 7.1 in the Sauer/Pai text except the generators are modeled using the subtransient GENROU model, and data is in per unit on generator MVA base (see next slide).
 - The Sauer/Pai book contains a derivation of the system models, and a fully worked initial solution for this case.
- **Case Name: WSCC_9Bus**

Generator MVA Base



- Like most transient stability programs, generator transient stability data in PowerWorld Simulator is entered in per unit using the generator MVA base.
- The generator MVA base can be modified in the “Edit Mode” (upper left portion of the ribbon), using the Generator Information Dialog. You will see the MVA Base in “Run Mode” but not be able to modify it.

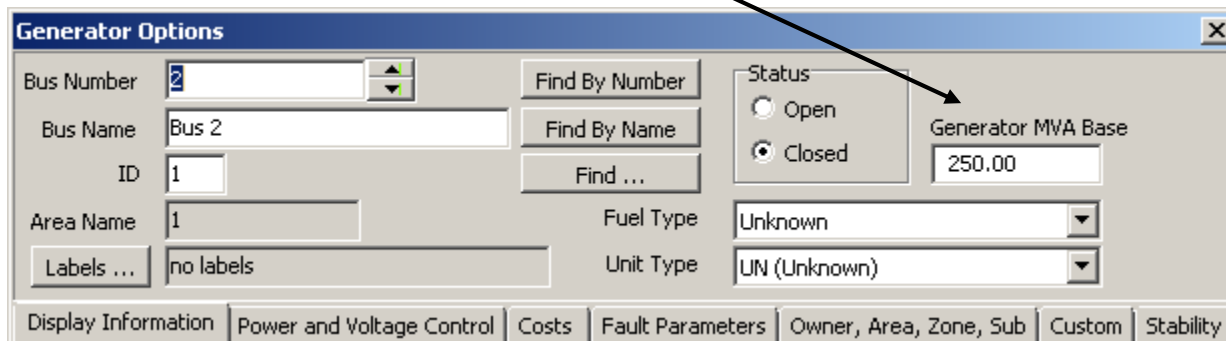

WSCC Case One-line

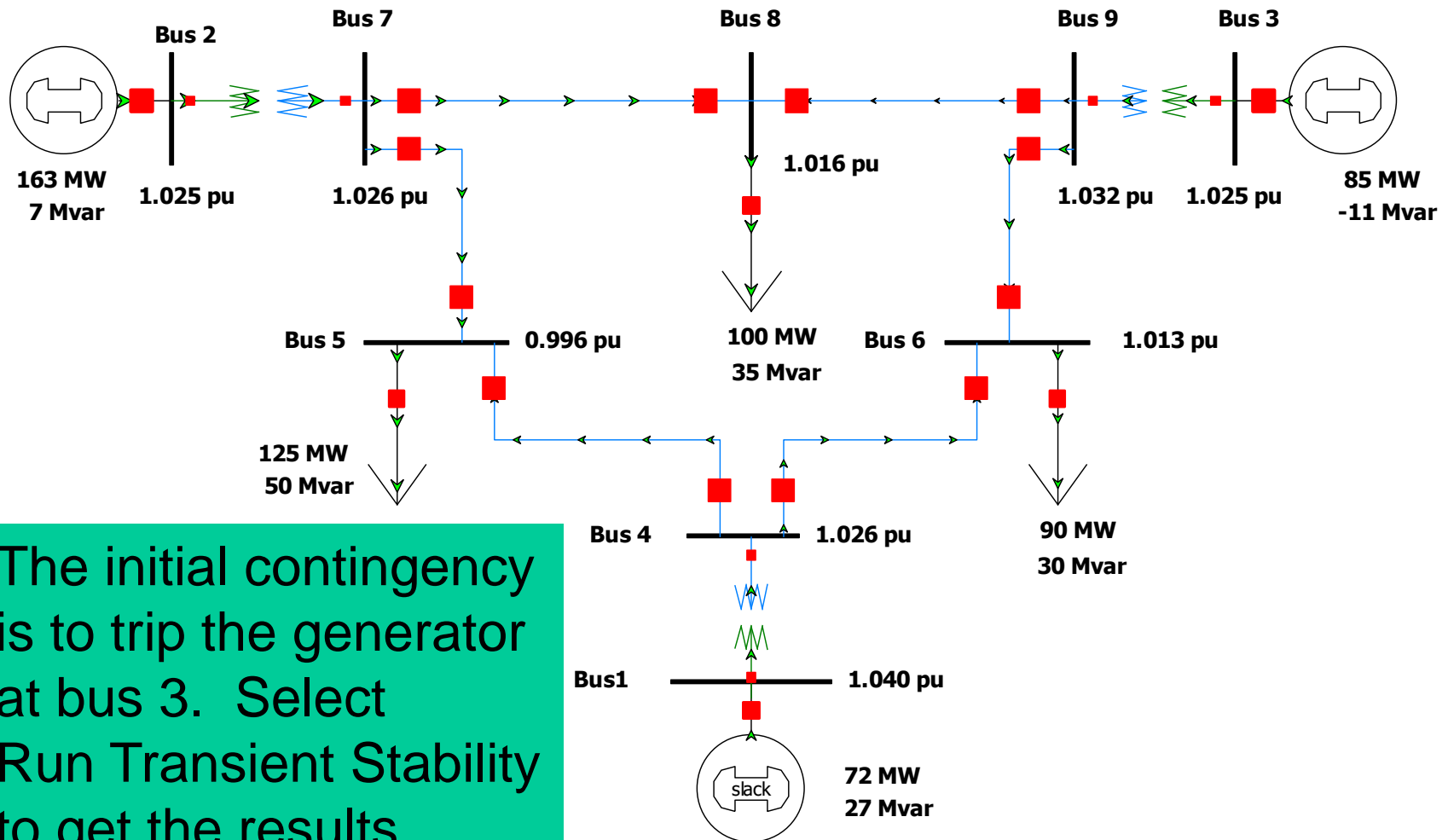

The initial contingency is to trip the generator at bus 3. Select Run Transient Stability to get the results.

Automatic Generator Tripping



Sometimes unseen errors may lurk in a simulation!

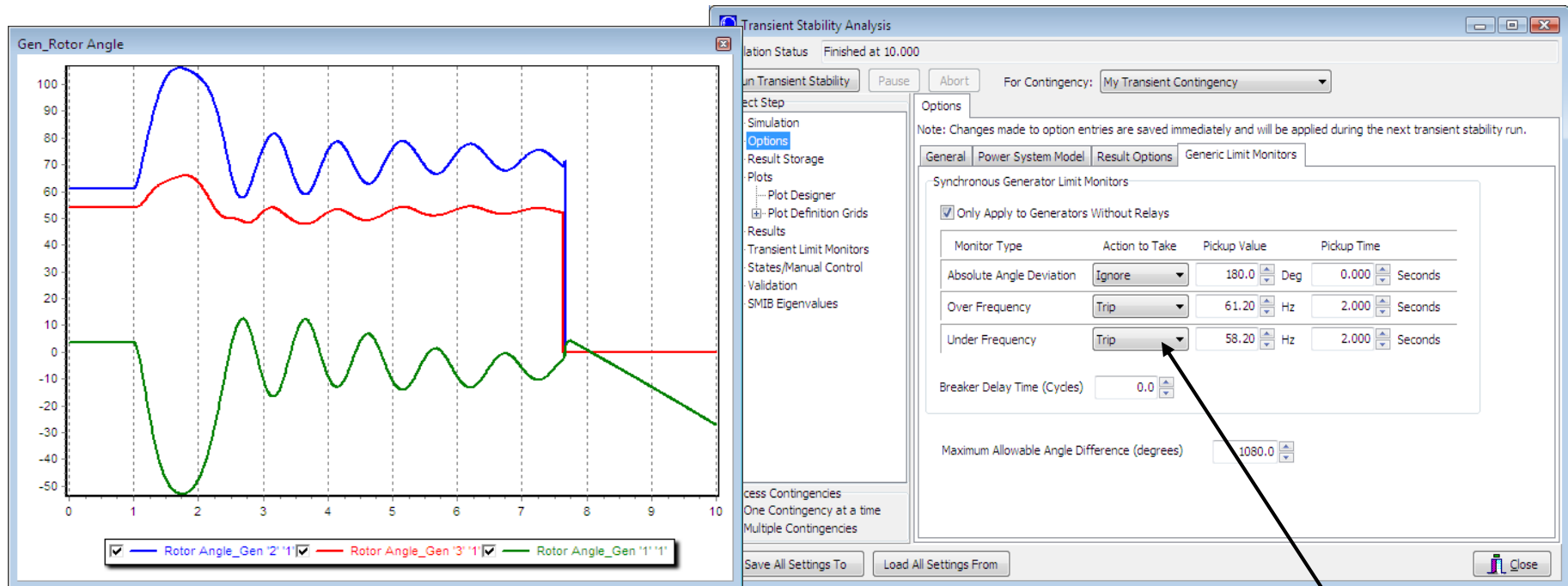

Because this case has no governors and no infinite bus, the bus frequency keeps rising throughout the simulation, even though the rotor angles are stable. Users may set the generators to automatically trip in “Options”, “Generic Limit Monitors”.

Generator Governors



- Governors are used to control the generator power outputs, helping the maintain a desired frequency
- Covered in sections 4.4 and 4.5
- As was the case with machine models and excitors, governors can be entered using the Generator Dialog.
- Add TGOV1 models for all three generators using the default values.

